



CaterSense -03

***GAS SUPPLY INTER-LOCK
with
FAN SPEED CONTROL***

***IMSTALLATION and COMMISSIONING
INSTRUCTIONS***

Product Overview

The CaterSense system is based on a range of products and ancillary equipment design to meet the ever changing requirements of the catering industry and associated regulations.

The system comes in four basic modes, you have selected

CaterSense -03 *Gas supply controller with multi-function solutions and speed control*

The controller has a unique "self-set" system which makes for easy system commissioning.

Contents

- 1.0 General Info
 - 1.01 Opening the unit
 - 1.02 Fixing details
 - 1.03 Cable entry
 - 1.04 Electrical connections
 - 1.05 System mode and set-up (locations)

- 2.0 Set-up and commissioning
 - 2.01 Initial Set-up
 - 2.02 Mode Set-up
 - 2.03 System Checking
 - 2.04 Troubleshooting

1.01 Opening the unit

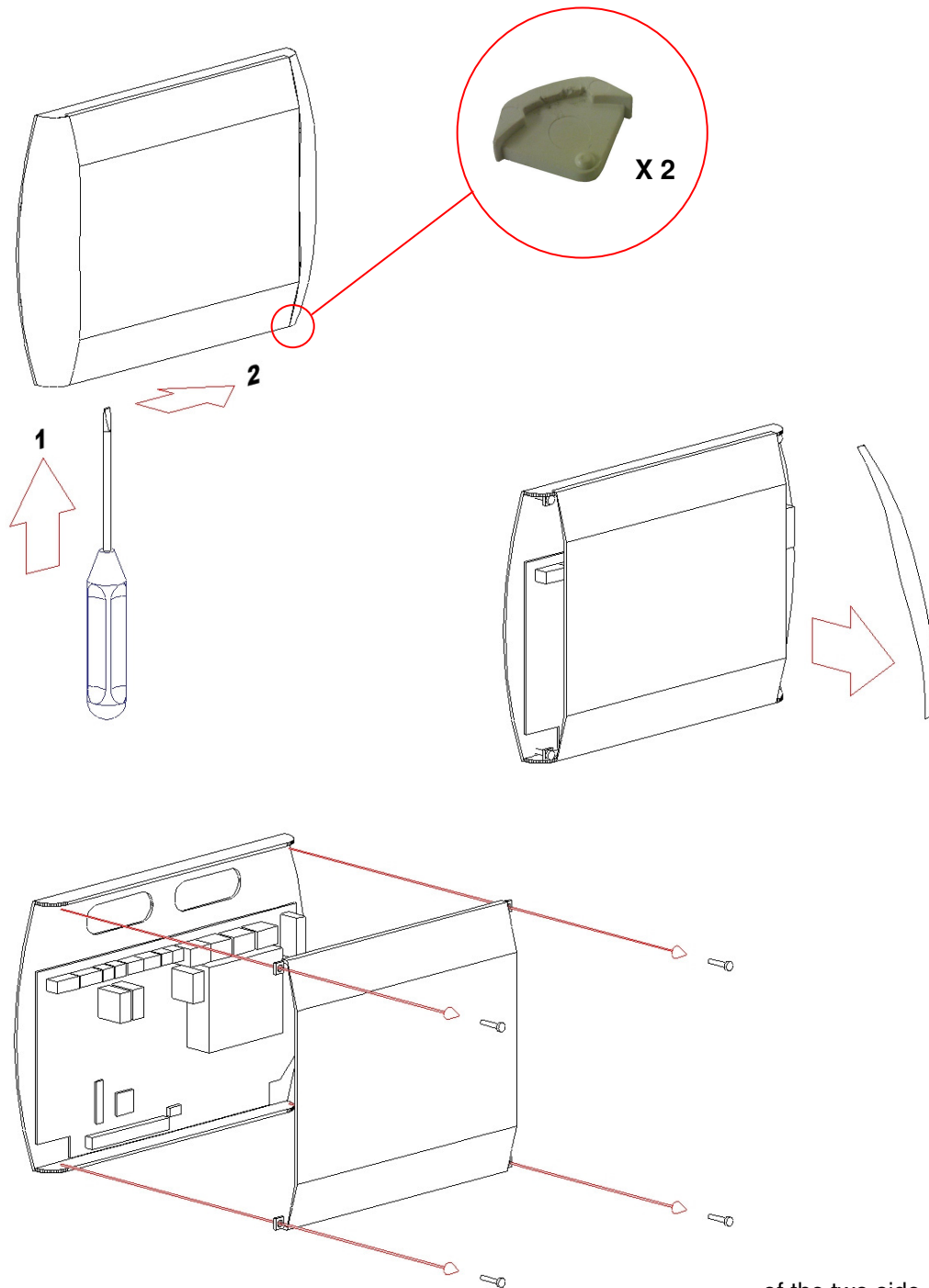

- 1) **of the two side panels:** using a flat bladed screwdriver push the clip from below away from each side panel.
- 2) Press the release pad on each side at the bottom of the enclosure and lift off each side panel in turn by first pulling the bottom towards you. This will reveal the four facia plate fixing screws.
- 3) Unscrew these four screws and lift the facia plate from the back box **(3)**, ensuring that the ribbon cable between the two PCBs has been unplugged at the main PCB end.

Place the screws, snap-in clips, side panels and facia plate in a safe place until the back box has been fixed, wired and is ready for reassembly and set-up

1.02 Fixing details

The CaterSense unit has six (6) mounting holes which can be used (as shown below)

Note: Ensure that the enclosure is mounted on a clean and level surface away from the direct cooking area or surfaces and in a dry area.

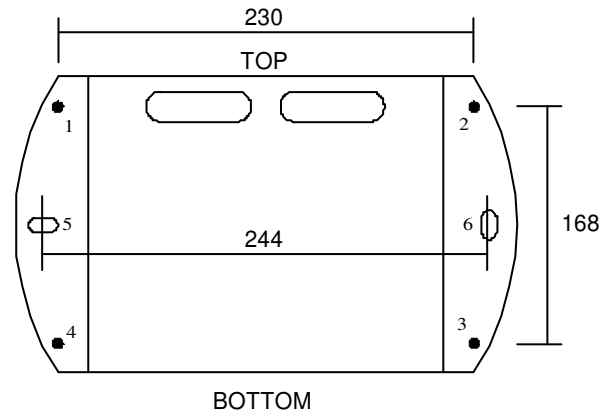

1.03 Cable entry

The CaterSense unit has two knock-out slots in the back of the enclosure (located at the top) to enable back entry. The enclosure has an area 190 x 25 mm which can be drilled for conduit entry on the top edge of the enclosure.

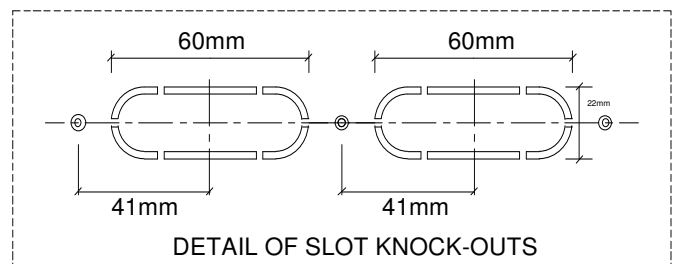

1.04 Electrical connections

The CaterSense system has two sets of terminals all mounted along the top edge of the main PCB circuit board.

Terminals 1 to 22 are the smaller terminals (1.5 mm² cable) and are used for the sensors, inter-locking devices, remote speed and on/off control. (Screen cable must be used).

Terminals 23 to 34 are the larger terminals (4 mm² cable) and are for the power connections for the fans, gas valve and power supply to the unit.

The terminals are of the rising clamp type protection.

All cabling should be kept to the top of the unit within the designated area. No cables should be placed or laid across the PCBs as they may cause damage.

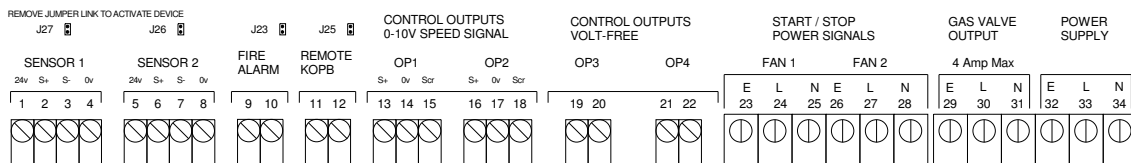

1.05 System mode and set-up

The CaterSense unit is a number of intelligent control solutions in one controller. Each of the solution types has a “Mode Code” which is set via a DIL switch mounted on the main PCB circuit board. The CaterSense also has a unique “Self-set” system commissioning tool which makes for easy system commissioning.

These devices are located on the left hand side of the main PCB, under the side cover, as detailed below.

Follow the instructions in the next section for your model of CaterSense.

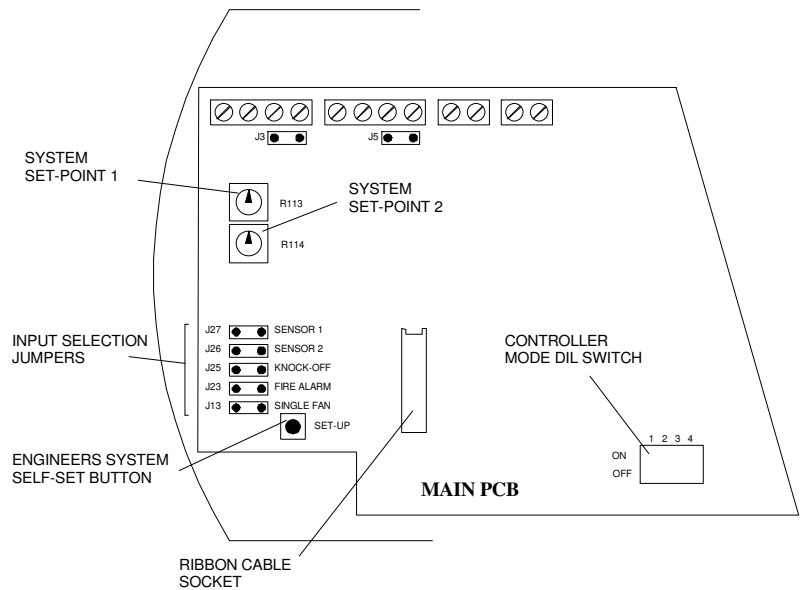

2.0 Set-up and Commissioning

The set-up and commissioning of your CaterSense system is in two parts, **Initial** and **Mode**.

2.01 Initial Set-up

Once all of the wiring has been completed and tested and the system is ready to be set-up and commissioned, the following sequence **MUST** be followed to ensure the CaterSense and system operate correctly.

- DIL Mode switch**, Ensure the correct system code has been selected on the DIL switch. This code is detailed on the System Mode page for your installation.
- Input Jumpers**, Ensure that the correct input jumpers have been removed as detailed on the System Mode page for your installation and jumper J13 is fitted if a single fan is being used.
- Sensor Links**, If you are using four wire sensors in place of three wire type, remove Link **J3 & J5** as detailed on the System Mode page for your installation.
- Ensure that fire alarm and knock-off switches (if fitted) are all in the operational position.
- Refit the CaterSense facia plate by plugging in the ribbon cable and fixing the four screws.
NOTE: Ensure the ribbon cable is plugged in correctly with the key pin at the top (*see: ribbon diagram for further information*).

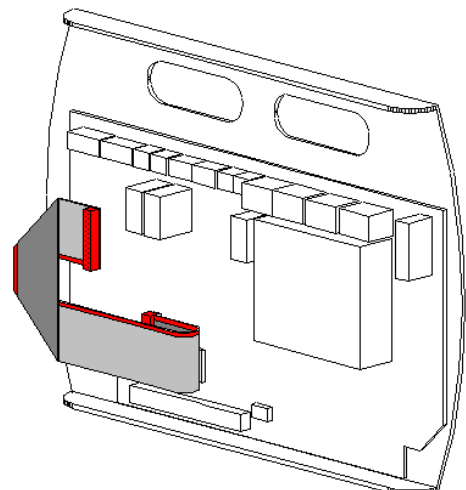



2.02 Mode Set-up – CaterSense 3

Once the above has been carried out, the system is now ready to be powered up.

The CaterSense unit is an intelligent unit with a self-set system and multi function LED indication. Within the next sequence of set-up instructions the CaterSense unit will give you feedback on the system and set-up via audible “beeps” and colour change / constant and flashing LEDs in a step by step sequence.

2.02.1 CaterSense 3

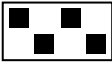
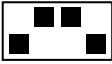
CaterSense 3 is a multi function controller with six (6) pre-programmed controller models in one unit. These six controllers are selected via the **DIL Mode** switch via a dedicated **Mode Code**.

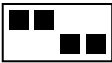





Mode Code	DIL mode	Description
03-02		SINGLE EXTRACT CANOPY with MANUAL SPEED CONTROL - FPM (Optional SUPPLY FAN with speed output RATIO ADJUSTMENT)
03-03		SINGLE EXTRACT CANOPY with MANUAL SPEED CONTROL - FPM (Optional SUPPLY FAN with speed output ratio adjustment) and GAS PRESSURE PROVING
03-04		SINGLE EXTRACT CANOPY with SYSTEM DEMAND FAN SPEED - FPM (Optional SUPPLY FAN with speed output ratio adjustment)
03-05		SINGLE EXTRACT CANOPY with SYSTEM DEMAND FAN SPEED - FPM (Optional SUPPLY FAN with speed output ratio adjustment) and GAS PRESSURE PROVING
03-06		SINGLE EXTRACT CANOPY with MANUAL SPEED CONTROL - FPM (Optional SUPPLY FAN with speed output ratio adjustment) GAS PRESSURE PROVING, and HEATER ENABLE



CaterSense – 03 Single Extract Fan Canopy with Manual Speed Control and Fan Power Monitoring (Optional Supply Fan) -

Mode Code 03-02 Set-up and commissioning









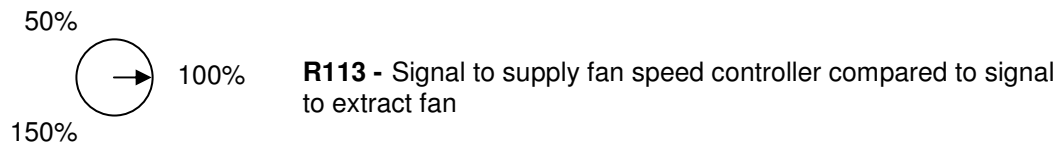



Self-Set sequence

The sequence detailed below MUST be followed to enable the CaterSense unit to program its parameters.

- 1) PRESS   SYSTEM CONDITION
 (Hold for 3 secs)  GAS VALVE
 FAN 1, FAN 2
 All other LEDs
 FAN SPEED

Balance your system supply and extract to the design air flow rate by setting the VCDs, min and max speed adjustments on your speed controller, ratio adjustment pot R113 on the main PCB, and  and  touch pads.



- 2) PRESS   SYSTEM CONDITION
 GAS VALVE
 FAN 1, FAN 2
 All other LEDs
 FAN SPEED
 2 mins

 GAS VALVE
 FAN 1, FAN 2
 All other LEDs
 FAN SPEED



The system will produce a short beep. The CaterSense will slowly reduce the speed of the fans to establish the characteristics of your system. **DO NOT INTERRUPT THIS PROCESS.** After approximately two minutes, the system will stop the fans. The set-up is now complete and the system is ready to run.

Note: Please refer to section 2.03 (System Checking) before starting the CaterSense unit to ensure that it has been successfully commissioned.

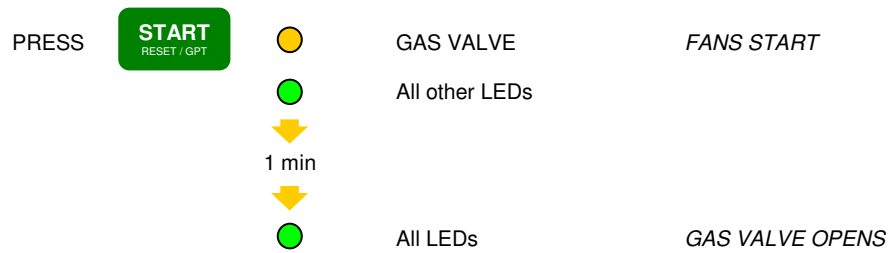
Functional Operation

The operation of the CaterSense unit and system in this Mode is as follows:



The speed of the extract fan can be changed using  and .

The supply fan will change speed according to the signal sent to it from CaterSense. This signal is a percentage of the signal to the extract fan, established using R113 during set-up.

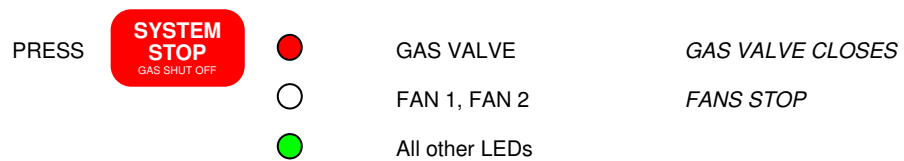

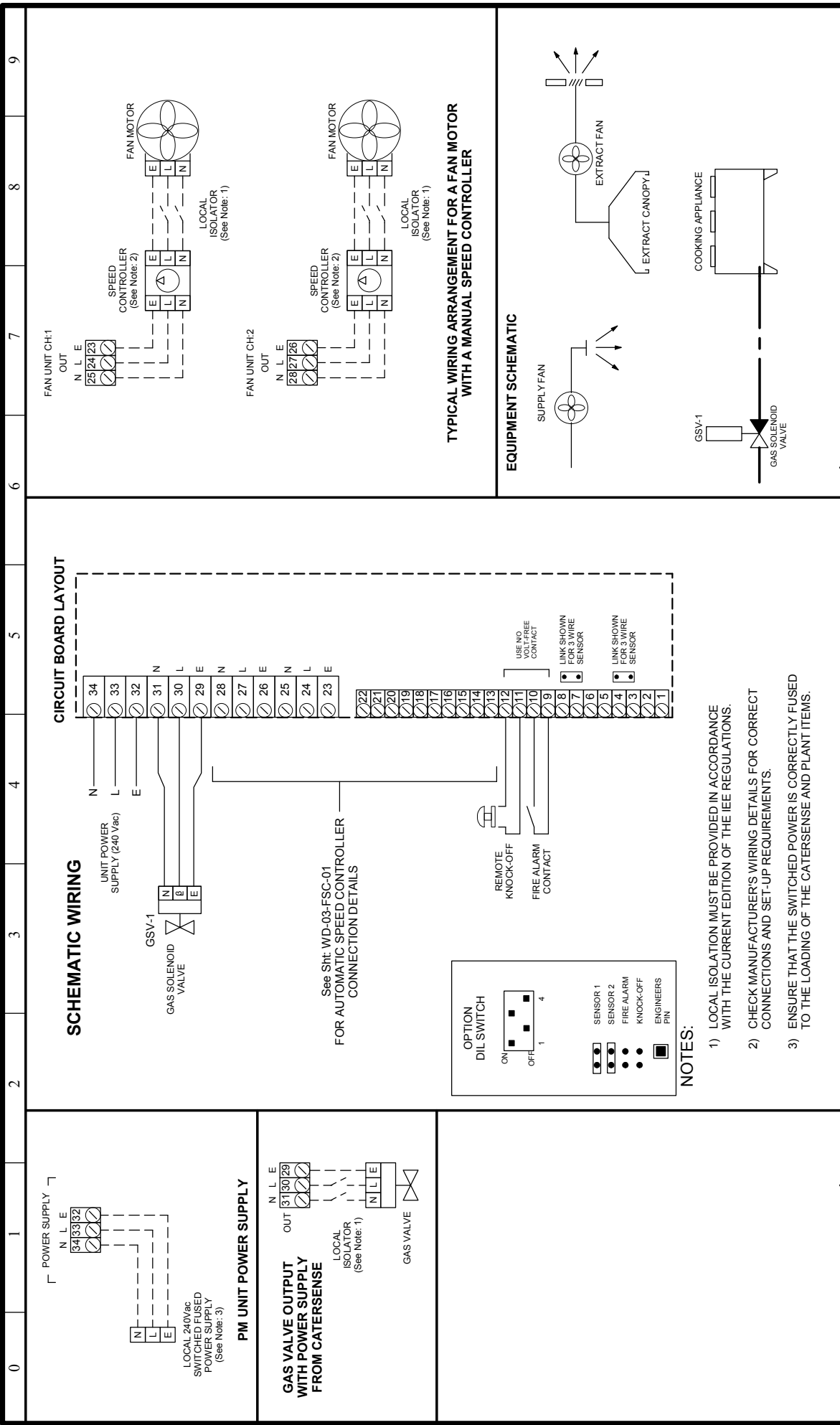





<p>TRENT PRODUCTS</p> <p>Tel: 01782 - 844688 Fax: 01782 - 844772</p>	<p>IF IN DOUBT, ASK</p>	<p>DATE:</p> <p>05/01/06</p>	<p>DRAWING No:</p> <p>CATERSENSE - 3 WD-03-02</p>	<p>DRAWN BY</p> <p>MAE</p>
---	--------------------------------	-------------------------------------	--	-----------------------------------

CaterSense – 03 Single Extract Fan Canopy with Manual Speed Control, Fan Power Monitoring and Gas Pressure Proving (Optional Supply Fan) -

Mode Code 03-03 Set-up and commissioning















Self-Set sequence



The sequence detailed below MUST be followed to enable the CaterSense unit to program its parameters.

- 1) PRESS   SYSTEM CONDITION
 (Hold for 3 secs)  GAS VALVE
 FAN 1, FAN 2
 All other LEDs

- 2) PRESS   GAS VALVE

The gas valve will open for a maximum of 5 minutes to allow for system checking.

- 3) PRESS   GAS VALVE
 10 sec
  GAS VALVE
 30 sec
  SYSTEM CONDITION
- 4) PRESS   SYSTEM CONDITION
 GAS VALVE
 FAN 1, FAN 2
 All other LEDs
 FAN SPEED

Balance your system supply and extract to the design air flow rate by setting the VCDs, min and max speed adjustments on your speed controller, adjustment pots R113 and R114 on the main PCB, and  and  touch pads.

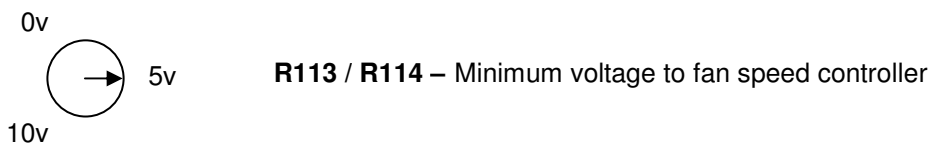

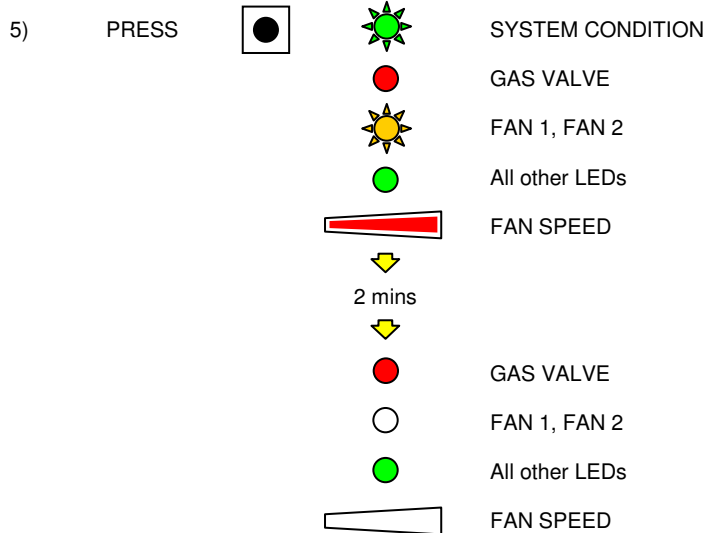



The system will produce a short beep. The CaterSense will slowly reduce the speed of the fans to establish the characteristics of your system. **DO NOT INTERRUPT THIS PROCESS.** After approximately two minutes, the system will stop the fans. The set-up is now complete and the system is ready to run.

Note: Please refer to section 2.03 (System Checking) before starting the CaterSense unit to ensure that it has been successfully commissioned.

Functional Operation

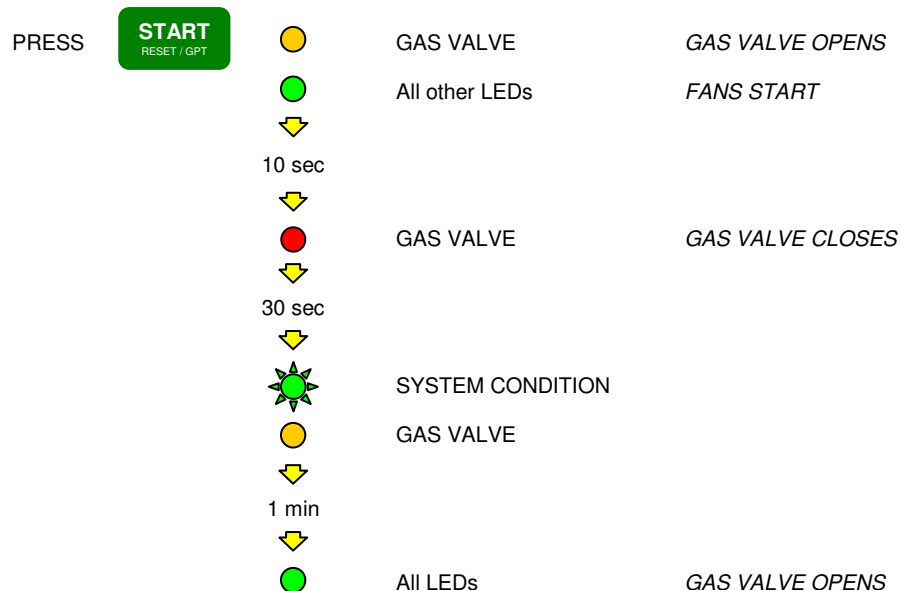
The operation of the CaterSense unit and system in this Mode is as follows:



The speed of the fans can be changed using  and 

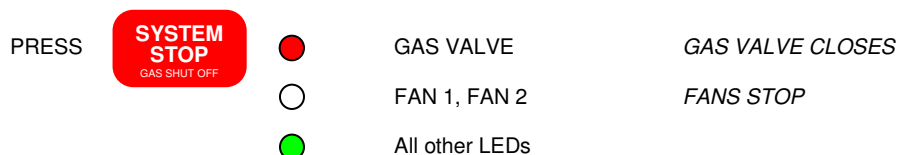

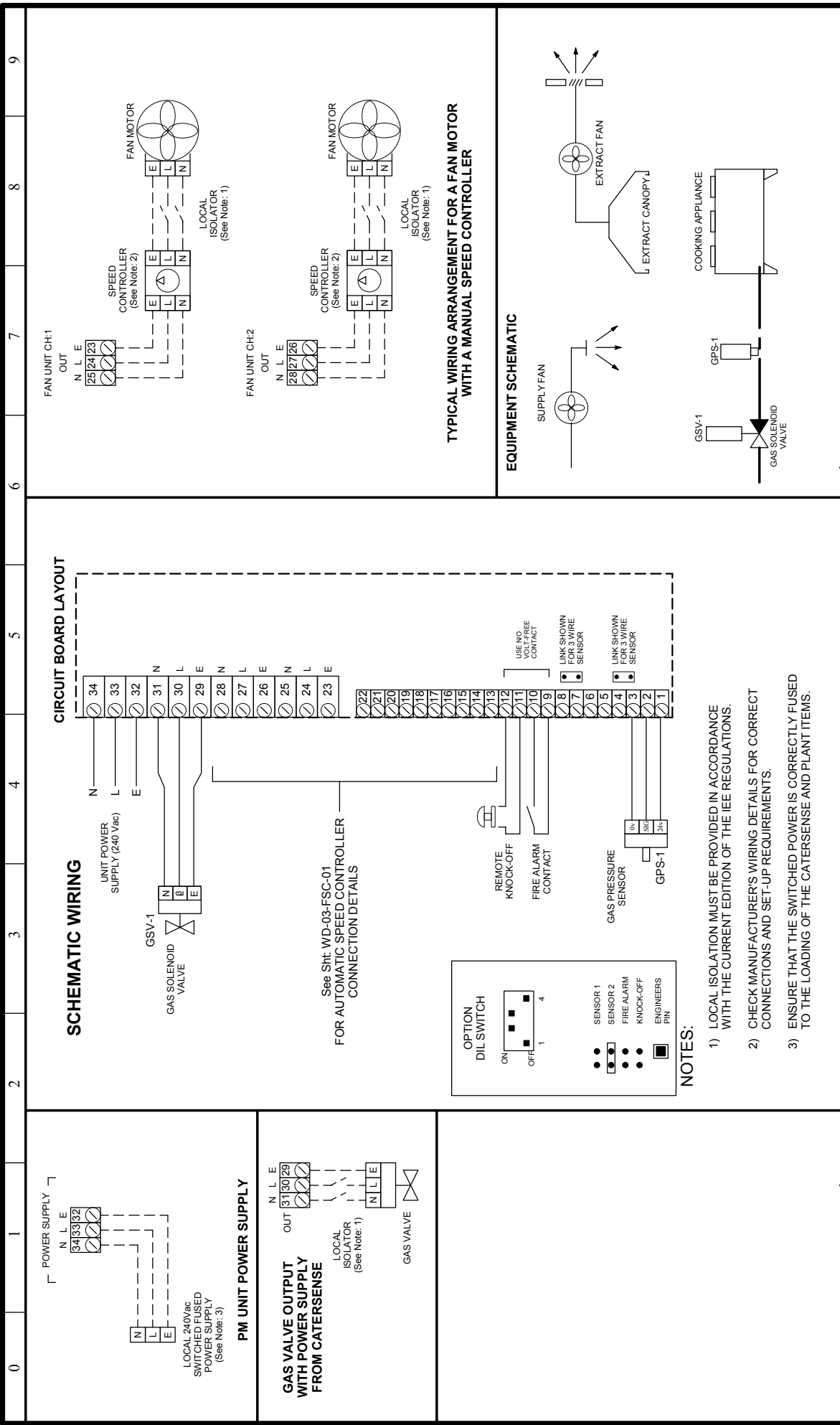

<p>TRENT PRODUCTS</p> <p>Tel: 01782 - 844688 Fax: 01782 - 844772</p>	<p>IF IN DOUBT, ASK</p>	<p>DATE:</p> <p>05/01/06</p>	<p>DRAWING No:</p> <p>CATERSENSE - 3 WD-03-03</p>	<p>DRAWN BY</p> <p>MAE</p>
---	--------------------------------	-------------------------------------	--	-----------------------------------

0	1	2	3	4	5	6	7	8	9						
<p>3 PHASE INVERTER SPEED CONTROLLERS</p> <p>LOCAL ISOLATORS (See Note: 1)</p> <p>CS-FSC... INVERTER UNIT TO BE READ IN-CONJUNCTION WITH INVERTER MANUFACTURER'S WIRING AND TECHNICAL INFORMATION</p>			<p>SINGLE PHASE TO 3 PHASE INVERTER SPEED CONTROLLERS</p> <p>LOCAL ISOLATORS (See Note: 1)</p> <p>CS-FSC... INVERTER UNIT TO BE READ IN-CONJUNCTION WITH INVERTER MANUFACTURER'S WIRING AND TECHNICAL INFORMATION</p>			<p>SINGLE PHASE 6.5amp SPEED CONTROLLERS WITH DIRECT POWER FEED FROM CATERSENSE</p> <p>LOCAL ISOLATORS (See Note: 1)</p> <p>CS-FSC-SP-6.5 UNIT TO BE READ IN-CONJUNCTION WITH WIRING AND TECHNICAL INFORMATION</p>				<p>EXTRACT FAN</p> <p>CATERSENSE TERMINALS</p>			<p>NOTES:</p> <ol style="list-style-type: none"> 1) LOCAL ISOLATION MUST BE PROVIDED IN ACCORDANCE WITH THE CURRENT EDITION OF THE IEE REGULATIONS. 2) CHECK MANUFACTURER'S WIRING DETAILS FOR CORRECT CONNECTIONS AND SET-UP REQUIREMENTS. 3) ENSURE THAT THE SWITCHED POWER IS CORRECTLY FUUSED TO THE LOADING OF THE CATERSENSE AND PLANT ITEMS. 		
<p>IF IN DOUBT, ASK</p>			<p>DATE:</p>			<p>DRAWING No:</p>				<p>DRAWN BY</p>					
<p>CATERSENSE - 3 (FSC) WIRING & CONNECTION DIAGRAM</p>			<p>05/01/06</p>			<p>CATERSENSE - 3 WD-03-FSC-01</p>				<p>MAE</p>					

CaterSense – 03 Single Extract Fan Canopy with Manual Speed Control, Fan Power Monitoring and Heater battery control (Optional Supply Fan) -



Mode Code 03-06 Set-up and commissioning

DIP SWITCH: 

Self-Set sequence

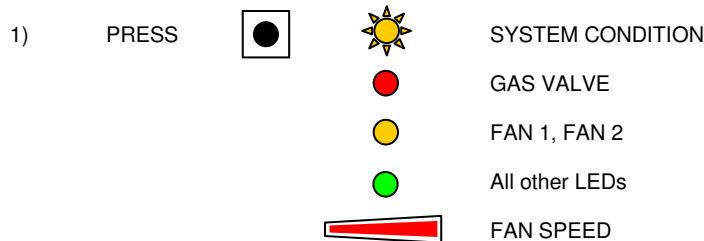
The sequence detailed below MUST be followed to enable the CaterSense unit to program its parameters.



Balance your system supply and extract to the design air flow rate by setting the VCDs, min and max speed adjustments on your speed controller  and  touch pads.

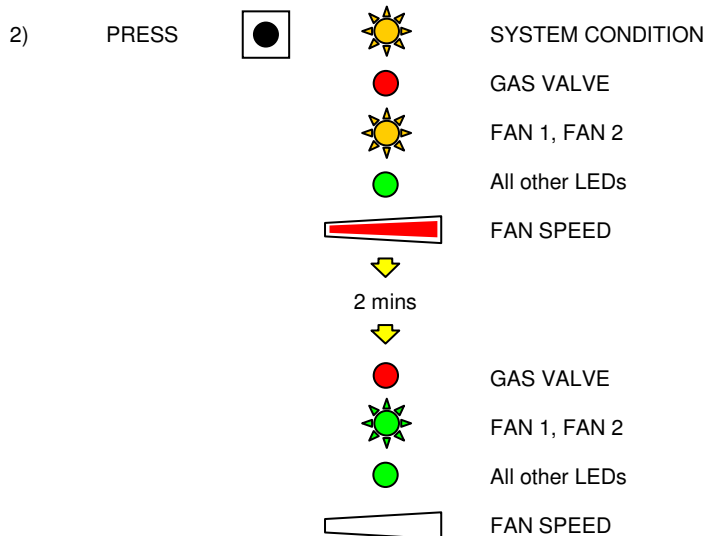

The system will produce a short beep. The CaterSense will slowly reduce the speed of the fans to establish the characteristics of your system. **DO NOT INTERRUPT THIS PROCESS.** After approximately two minutes, the set-up is complete and the system is ready to run. The fans will run on for 15 mins for heat dissipation purposes. During this period the FAN 1 and FAN 2 LEDs will flash.

The setpoint for the tempered air control can be adjusted from 18°C ± 3°C using pot R114 on the main PCB.

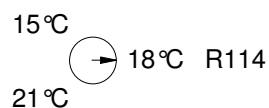



Note: Please refer to section 2.03 (System Checking) before starting the CaterSense unit to ensure that it has been successfully commissioned.

Functional Operation

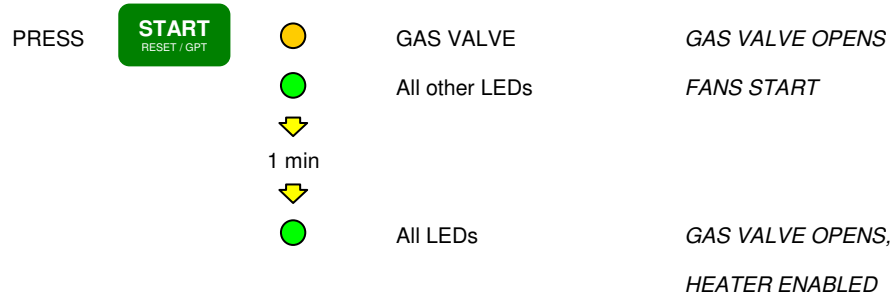
The operation of the CaterSense unit and system in this Mode is as follows:



The speed of the fan can be changed using  and  .

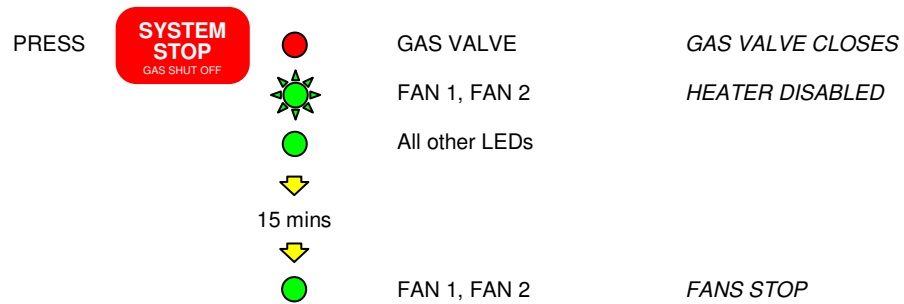

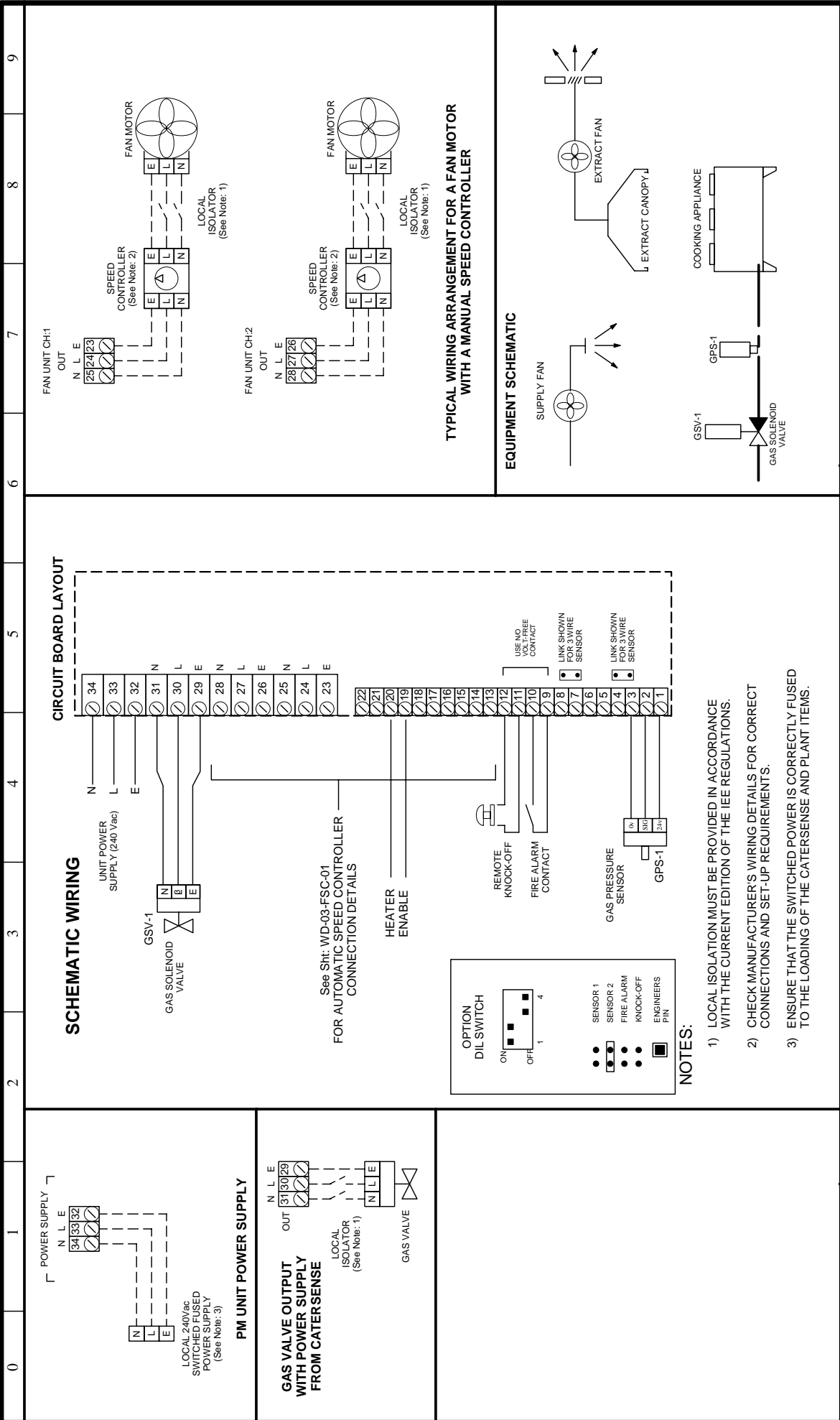

<p>TRENT PRODUCTS</p> <p>Tel: 01782 - 844688 Fax: 01782 - 844772</p>	<p>IF IN DOUBT, ASK</p>	<p>DATE:</p> <p>05/01/06</p>	<p>DRAWING No:</p> <p>CATERSENSE - 3 WD-03-06</p>	<p>DRAWN BY</p> <p>MAE</p>
---	--------------------------------	-------------------------------------	--	-----------------------------------

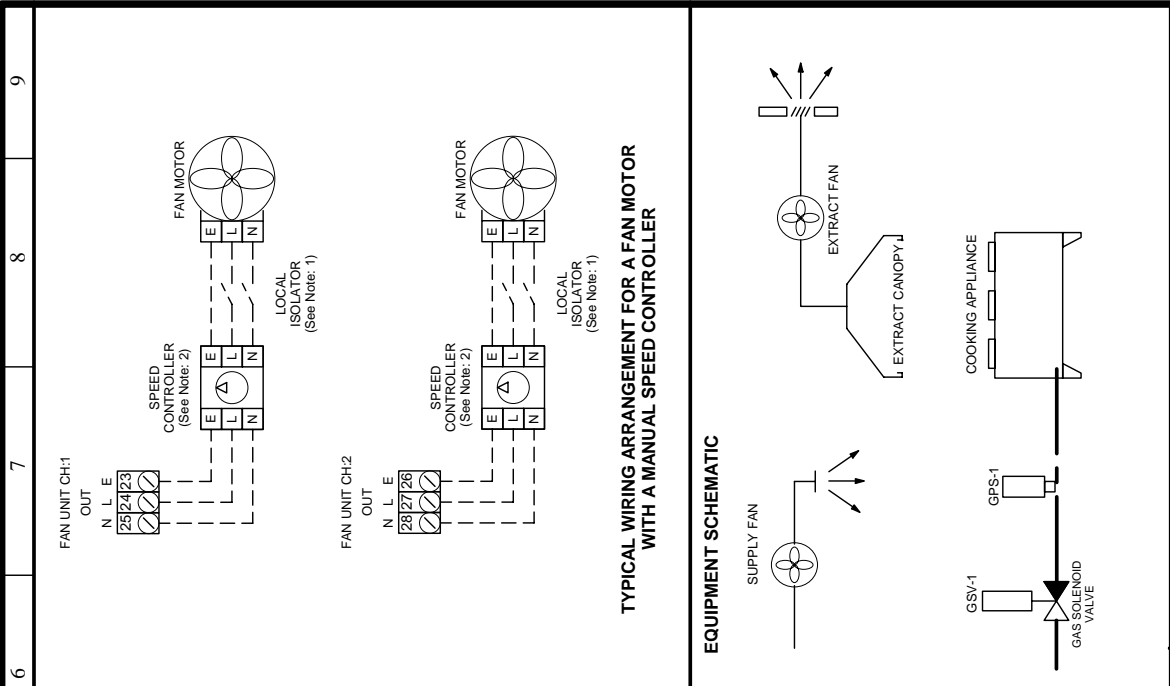

2.03 System Checking

As an aid to system commissioning, CaterSense has a diagnostic tool which can be used to quickly check that the stored settings are suitable for correct operation.

To access this tool,

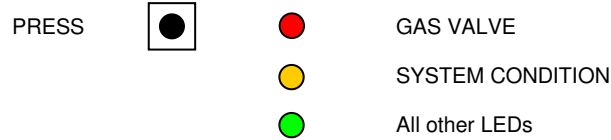

In this mode, the FAN 1 and FAN 2 LEDs will instantly react to the current being drawn by the attached motors. By slowly adjusting the speed control for the motors and observing the LEDs, the parameters can be quickly checked and problems identified.

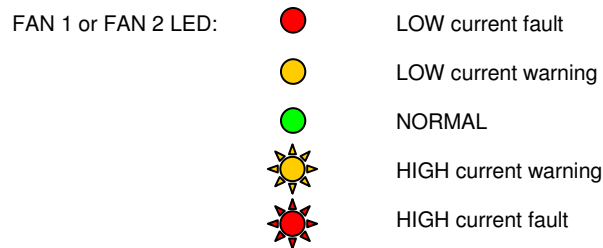

If the current is at a "fault" level for longer than 30s, a system fault would occur during normal operation. It is normal for current draw to fall outside normal levels for a few seconds whilst changing speeds. Allow fan to settle at each speed. IF IN DOUBT, ASK.

Diagnostic mode also allows the manual opening of the gas valve for testing purposes, for a maximum of 5 minutes.

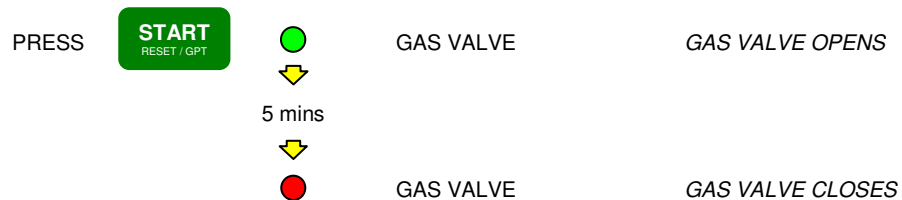







To leave diagnostic mode, press









2.04 Troubleshooting

2.04.1 - SYSTEM STOPPED

	POWER ON		GAS VALVE
	SYSTEM CONDITION		
	REMOTE KNOCK OFF		FAN 1
	FIRE ALARM		FAN 2







Cause: - The system has been stopped
Solution: - Press "Start" key to begin startup sequence

2.04.2 - FIRE ALARM

	POWER ON		GAS VALVE
	SYSTEM CONDITION		
	REMOTE KNOCK OFF		FAN 1
	FIRE ALARM		FAN 2







Cause: - The link between terminals 9 and 10 has been broken (fire alarm activated). The fan and gas valve outputs will be deactivated.
Solution: - Ensure fire alarm is not activated. Check wiring to fire alarm Interface panel. The system must be reset by pressing "STOP" before it can be restarted.

2.04.3 - KNOCK OFF BUTTON

	POWER ON		GAS VALVE
	SYSTEM CONDITION		
	REMOTE KNOCK OFF		FAN 1
	FIRE ALARM		FAN 2

Cause: - The link between terminals 11 and 12 has been broken (knock off pressed). The gas valve output will be deactivated.
Solution: - Ensure remote knock off button has been released. Check wiring to remote knock-off button. The system must be reset by pressing "STOP" before it can be restarted.

2.04.4 - FAN UNDERCURRENT

	POWER ON		GAS VALVE
	SYSTEM CONDITION		
	REMOTE KNOCK OFF		FAN 1 or FAN 2
	FIRE ALARM		







Cause: - The indicated fan is drawing less current than the minimum current established during commissioning.
Solution: - Ensure fan is working correctly. Check running current with an ammeter. Use the diagnosis mode to establish any problems with set-up. The system must be reset by pressing "STOP" before it can be restarted.

2.04.5 - FAN OVERCURRENT

 POWER ON	 GAS VALVE
 SYSTEM CONDITION	
 REMOTE KNOCK OFF	 FAN 1 or FAN 2
 FIRE ALARM	







Cause: - The indicated fan is drawing more current than the maximum current established during commissioning.
Solution: - Ensure fan is working correctly. Check running current with an ammeter. Check filters are clean. Use the diagnosis mode to establish any problems with set-up. The system must be reset by pressing "STOP" before it can be restarted.

2.04.6 - GAS PRESSURE FAULT 1

 POWER ON	 GAS VALVE
 SYSTEM CONDITION	
 REMOTE KNOCK OFF	 FAN 1
 FIRE ALARM	 FAN 2







Cause: - The system has failed its initial gas pressure test.
Solution: - Ensure all gas appliances are off. Check wiring to gas pressure sensor. Check gas pressure. The system must be reset by pressing "STOP" before it can be restarted.

2.04.7 - GAS PRESSURE FAULT 2

 POWER ON	 GAS VALVE
 SYSTEM CONDITION	
 REMOTE KNOCK OFF	 FAN 1
 FIRE ALARM	 FAN 2

Cause: - The gas pressure has dropped below 12mbar during normal running.
Solution: - See above.

2.04.8 - MEMORY ERROR

 POWER ON	 GAS VALVE
 SYSTEM CONDITION	
 REMOTE KNOCK OFF	 FAN 1
 FIRE ALARM	 FAN 2

Cause: - The system has failed the test of its internal memory (tested at power on).
Solution: - The system must be recommissioned to store new values into the memory. Please contact a competent person and consult your installation manual.

If the above does not solve your problem, contact Trent Products.

** Only on modes with gas pressure proving*

FOR FURTHER TECHNICAL ASSISTANCE, PLEASE CONTACT US BY

Phone: 01782 844688

Fax: 01782 844772

E-mail: info@trentproducts.com

Web site: www.trentproducts.com

- Note:
- i) Ensure that the electrical installation has been installed in accordance with the current edition of the IEE regulations.
 - ii) Ensure that the gas installation has been installed in accordance with the current gas regulations and GAS SAFE guide-lines.
 - iii) Ensure that the ventilation and extract system has been set to the correct air flow design levels in accordance with the current regulations.
 - iv) If in doubt, ask! (Contact us on or by any of the above).
 - v) Ensure that the client has been shown how to operate the system and that they have been handed the users guide.



This symbol on this product or the package indicates that disposal of this product after its lifecycle could harm the environment.
DO NOT dispose of this product (or batteries if used) as unsorted municipal waste. It should be disposed by a specialised company for recycling.
This product should be returned to your distributor or to a local recycling service. Respect the local environment rules.

TRENT PRODUCTS
Trent House
Dewsbury Road
Fenton
Stoke-on-Trent
Tel: 01782 844688 Fax: 01782 844772