

CaterSense the Intelligent answer



CaterSense -02

***GAS SUPPLY CONTROL with
GAS PRESSURE PROVING
AND OR REMOTE CT MONITORING
AND FAN MONITORING***

***INSTALLATION and COMMISSIONING
INSTRUCTIONS***

CaterSense *the Intelligent answer*

Product Overview

The CaterSense system is based on a range of products and ancillary equipment designed to meet the ever changing requirements of the catering industry and associated regulations.

The system comes in four basic modes, you have selected

CaterSense -02 intelligent controller *C/W current monitoring (on board or remote) and optional Gas Pressure Proving*

The controller has a unique "self-set" system which makes for easy system commissioning.

Contents

- 1.0 General Info
 - 1.01 Opening the unit
 - 1.02 Fixing details
 - 1.03 Cable entry
 - 1.04 Electrical connections
 - 1.05 System mode and set-up (locations)
- 2.0 Set-up and commissioning
 - 2.01 Initial Set-up
 - 2.02 Mode Set-up
 - 2.03 Functional Operation
 - 2.04 Troubleshooting
 - 2.05 System Checking

1.01 Opening the unit

The CaterSense unit is made up of the following component parts. Please ensure that all components are present before proceeding.

Product code	Quantity	Description
CS-02-PCB-B1	1	CaterSense-02 enclosure base including main PCB
CS-02-F1	1	CaterSense-02 enclosure facia including PCB
CS-CABLE	1	200mm ribbon cable
CS-SP-01	1	CaterSense enclosure side panel (left)
CS-SP-02	1	CaterSense enclosure side panel (right)
CS-SP-03	2	CaterSense enclosure side panel restraining clip
SCR-03	4	CaterSense facia fixing screw (<i>No 8 x 3/4"</i>)

CaterSense the Intelligent answer

1.

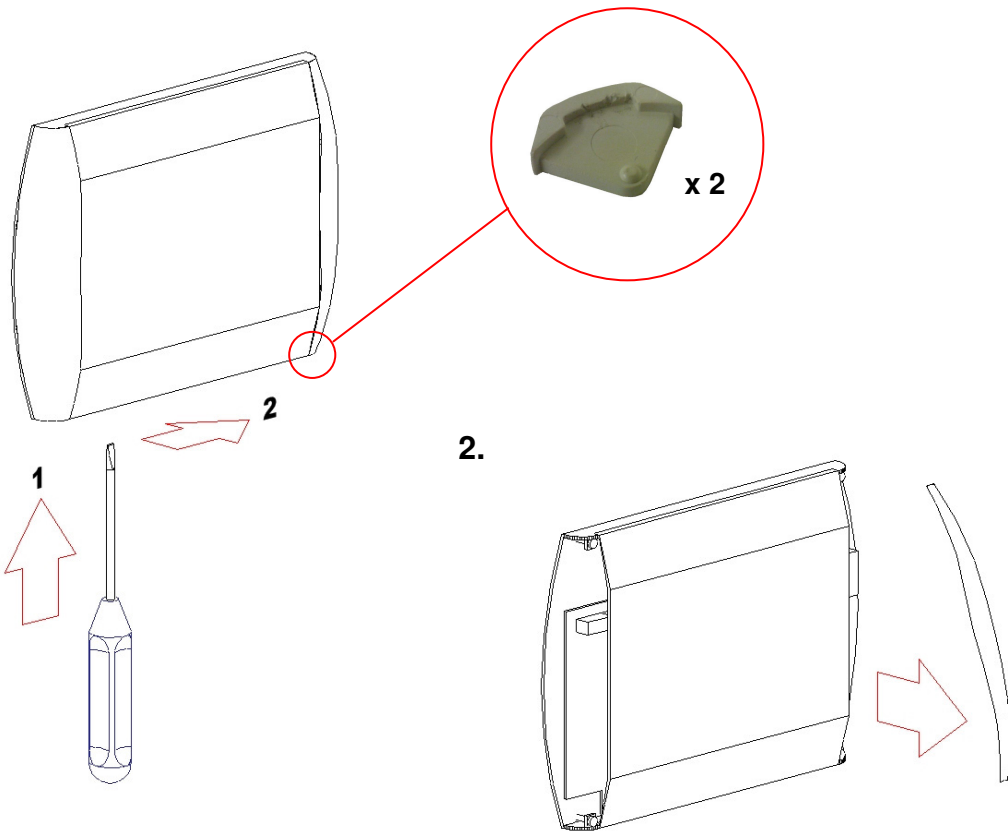

3.

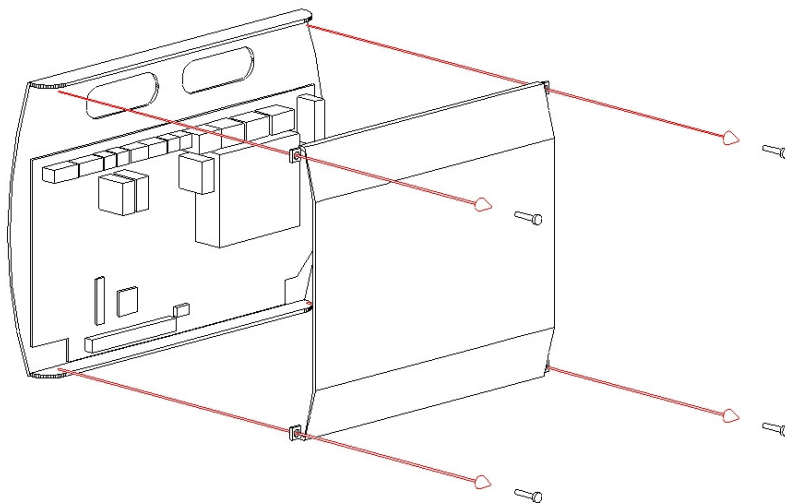

- 1) To open the enclosure, first remove the snap-in clips at the bottom of the two side panels: using a flat bladed screwdriver push the clip from below away from each side panel.
- 2) Press the release pad on each side at the bottom of the enclosure and lift off each side panel in turn by first pulling the bottom towards you. This will reveal the four fascia plate fixing screws.
- 3) Unscrew these four screws and lift the fascia plate from the back box (3), ensuring that the ribbon cable between the two PCBs has been unplugged at the main PCB end.

Place the screws, snap-in clips, side panels and fascia plate in a safe place until the back box has been fixed, wired and is ready for reassembly and set-up.

CaterSense the Intelligent answer

1.02 Fixing details

The CaterSense unit has six (6) mounting holes which can be used (as shown below)

Note: Ensure that the enclosure is mounted on a clean and level surface away from the direct cooking area and potentially wet areas.

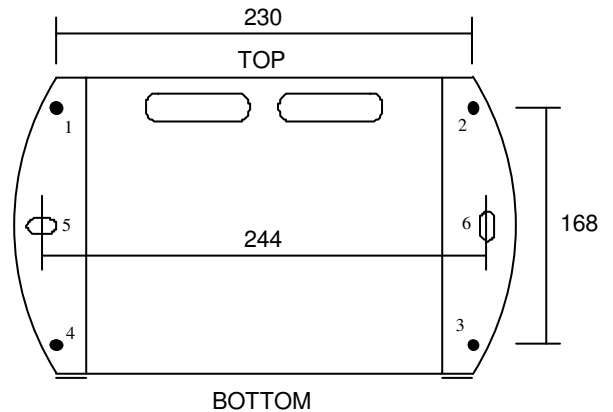

1.03 Cable entry

The CaterSense unit has two knock-out slots in the back of the enclosure (located at the top) to enable back entry. The enclosure has an area 190 x 25 mm which can be drilled for conduit entry on the top edge of the enclosure.

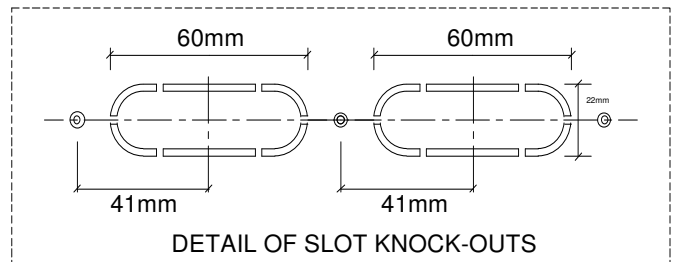

1.04 Electrical connections

The CaterSense system has two sets of terminals all mounted along the top edge of the main PCB circuit board.

Terminals 1 to 22 are the smaller terminals (1.5 mm² cable) and are used for the sensors (Screened cable must be used).

Terminals 29 to 34 are the larger terminals (4 mm² cable) and are for the power connections for the fans, gas valve and power supply to the unit.

The terminals are of the rising clamp type protection.

All cabling should be kept to the top of the unit within the designated area. No cables should be placed or laid across the PCBs as they may cause damage.



CaterSense the Intelligent answer

1.05 System mode and set-up

The CaterSense unit is a number of intelligent control solutions in one controller. Each of the solution types has a “Mode Code” which is set via a DIL switch mounted on the main PCB circuit board. The CaterSense also has a unique “Self-set” system commissioning tool which makes for easy system commissioning. These devices are located on the left hand side of the main PCB, under the side cover, as detailed below.

Follow the instructions in the next section for your model of CaterSense.

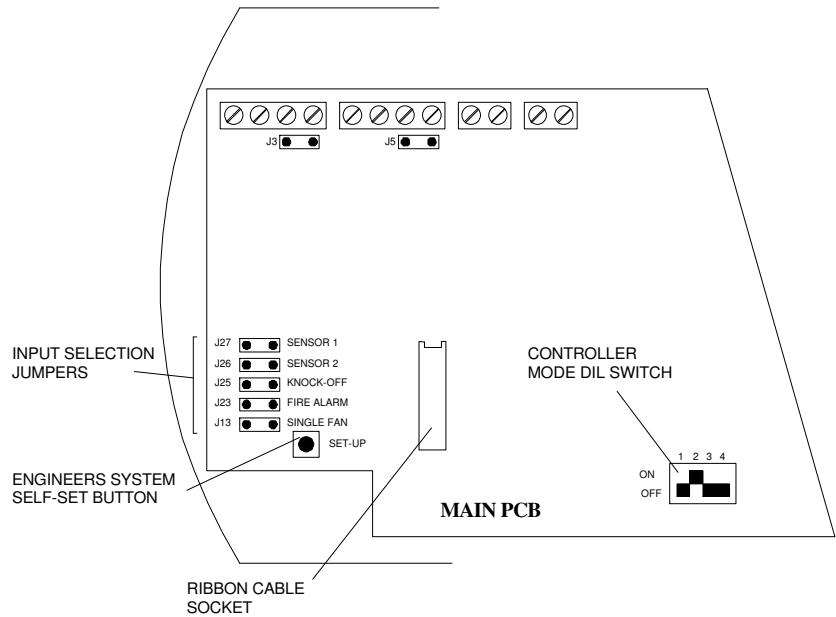

2.0 Set-up and Commissioning

The set-up and commissioning of your CaterSense system is in two parts, **Initial** and **Mode**.

2.01 Initial Set-up

Once all of the wiring has been completed and tested and the system is ready to be set-up and commissioned, the following sequence **MUST** be followed to ensure the CaterSense and system operate correctly.

- DIL Mode switch**, Ensure the correct system code has been selected on the DIL switch. This code is detailed on the wiring diagram for your installation.
- Input Jumpers**, Ensure that the correct input jumpers have been removed as detailed on the System Mode page for your installation.
- Sensor Links**, If you are using four wire sensors in place of three wire type, remove Link **J3 & J5** as detailed on the System Mode page for your installation.
- Ensure that fire alarm and knock-off switches (if fitted) are all in the operational position.

When all of the above stages have been completed, re-assemble the CaterSense unit by reversing the sequence described above in section **1.01**.

NOTE: Ensure the ribbon cable is plugged in correctly with the key pin (red stripe) at the **top** on the main PCB, and at the **bottom** on the fascia (see diagram).

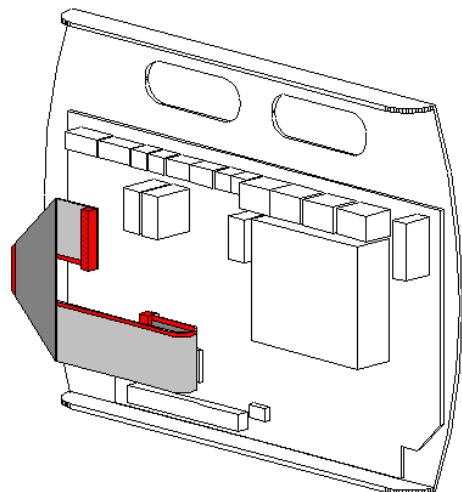







CaterSense the Intelligent answer

2.02 Mode Set-up









Once the above has been carried out, the system is now ready to be powered up.





The CaterSense-02 unit is pre-set to close the gas solenoid valve if it detects gas pressure below 12 mbar. The unit also tests the integrity of the pipework during every start up by opening the gas valve for 10 seconds, and then closing it for 30 seconds. If a significant drop in pressure is detected during this time, the CaterSense unit will not open the valve. The CaterSense-02 has an inbuilt facility to open the gas valve for a maximum of 5 minutes to allow for system checking.

- 1) PRESS   SYSTEM CONDITION
(Hold for 3 secs)  GAS VALVE
 GAS PRESSURE
 FAN
 All other LEDs

- 2) PRESS   GAS VALVE

The gas valve will open for a maximum of 5 minutes to allow for system checking. The internal gas pressure test can then be activated.





- 3) PRESS   GAS VALVE
 10 sec
  GAS VALVE
 30 sec
  SYSTEM CONDITION
 GAS PRESSURE

- 4) PRESS   SYSTEM CONDITION
 GAS VALVE
 FAN
 All other LEDs

Ensure the fans are running at the speed at which they draw least current. THIS IS NOT NECESSARILY THE LOWEST SPEED. IMPORTANT – allow system to run and settle.

If the fan is monitored via an external source, and the "fan healthy" signal is provided from a volt-free contact, ensure that the contact is closed.

CaterSense *the Intelligent answer*

- 5) PRESS   SYSTEM CONDITION
 GAS VALVE
 FAN
 All other LEDs

The system will produce a short beep. Change the speed of the fans to the speed at which they draw maximum current. THIS IS NOT NECESSARILY THE HIGHEST SPEED. IMPORTANT – allow system to run and settle.

If the fan is monitored via an external source, and the "fan healthy" signal is provided from a volt-free contact, ensure that the contact is closed.

- 6) PRESS   GAS VALVE
 All other LEDs

The set-up is now complete and the system is ready to run.

Note: Please refer to section 2.05 (System Checking) before starting the CaterSense unit to ensure that it has been successfully commissioned.

CaterSense *the Intelligent answer*

2.03 Functional Operation

The operation of the CaterSense unit and system in this Mode is as follows:

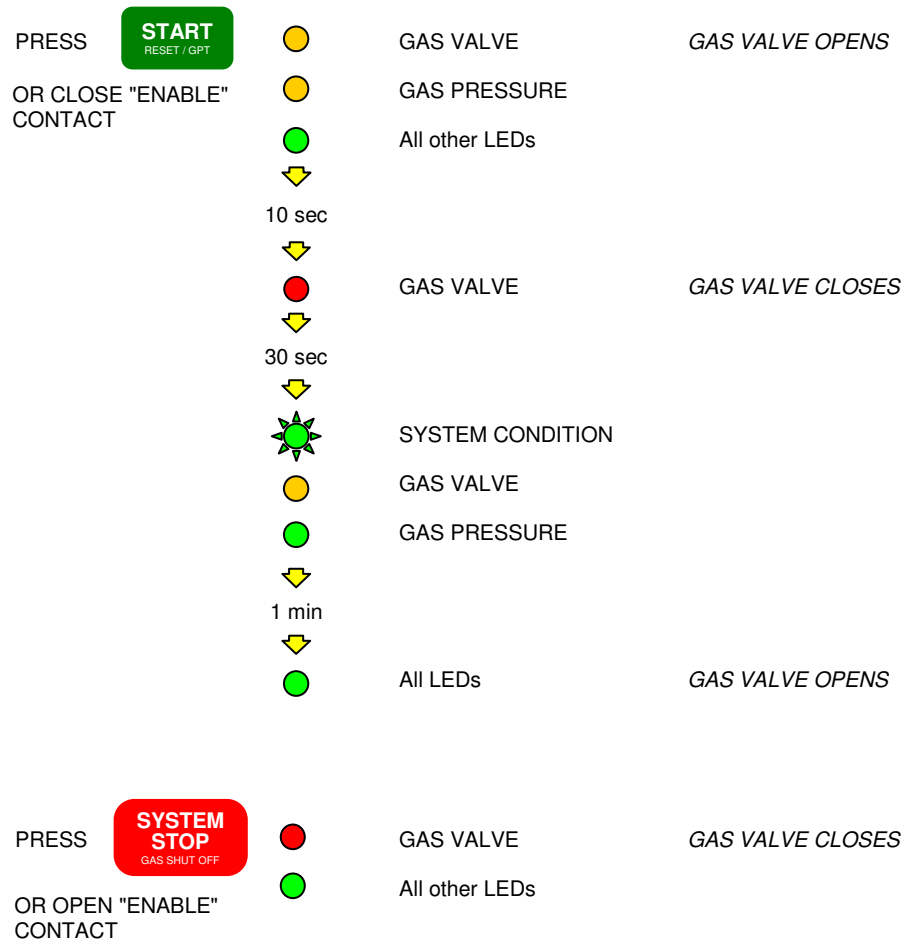







In the event of a system fault (i.e. gas pressure fault, fan failure, knock-off button depressed, fire alarm detected) the system must be reset by pressing **SYSTEM STOP**, or for systems with remote start/stop, opening and closing the enable contact.

On systems with remote start/stop, if the local **SYSTEM STOP** pad is pressed, the system stops immediately. This can be reset by either pressing **SYSTEM STOP** again, or by opening and then closing the enable contact.

CaterSense the Intelligent answer







2.04 Troubleshooting

2.041 - SYSTEM STOPPED

 POWER ON	 GAS VALVE
 SYSTEM CONDITION	
 REMOTE KNOCK OFF	 GAS PRESSURE
 FIRE ALARM	 FAN







Cause: - The system has been stopped
Solution: - Press "Start" key to begin startup sequence

2.042 - FIRE ALARM

 POWER ON	 GAS VALVE
 SYSTEM CONDITION	
 REMOTE KNOCK OFF	 GAS PRESSURE
 FIRE ALARM	 FAN







Cause: - The link between terminals 9 and 10 has been broken (fire alarm activated).The fan and gas valve outputs will be deactivated.
Solution: - Ensure fire alarm is not activated. Check wiring to fire alarm interface panel. The system must be reset by pressing "STOP" before it can be restarted.

2.043 - KNOCK OFF BUTTON

 POWER ON	 GAS VALVE
 SYSTEM CONDITION	
 REMOTE KNOCK OFF	 GAS PRESSURE
 FIRE ALARM	 FAN

Cause: - The link between terminals 11 and 12 has been broken (knock off pressed). The gas valve output will be deactivated.
Solution: - Ensure remote knock off button has been released. Check wiring to remote knock-off button. The system must be reset by pressing "STOP" before it can be restarted.

2.044 - FAN UNDERCURRENT

 POWER ON	 GAS VALVE
 SYSTEM CONDITION	
 REMOTE KNOCK OFF	 GAS PRESSURE
 FIRE ALARM	 FAN

Cause: - The indicated fan is drawing less current than the minimum current established during commissioning.
Solution: - Ensure fan is working correctly. Check running current with an ammeter. Use the diagnosis mode to establish any problems with set-up. The system must be reset by pressing "STOP" before it can be restarted.

CaterSense the Intelligent answer







2.045 - FAN OVERCURRENT

	POWER ON		GAS VALVE
	SYSTEM CONDITION		
	REMOTE KNOCK OFF		GAS PRESSURE
	FIRE ALARM		FAN

Cause: - The indicated fan is drawing more current than the maximum current established during commissioning.

Solution: - Ensure fan is working correctly. Check running current with an ammeter. Check filters are clean. Use the diagnosis mode to establish any problems with set-up. The system must be reset by pressing "STOP" before it can be restarted.

2.046 - GAS PRESSURE FAULT 1

	POWER ON		GAS VALVE
	SYSTEM CONDITION		
	REMOTE KNOCK OFF		GAS PRESSURE
	FIRE ALARM		FAN

Cause: - The system has failed its initial gas pressure test.

Solution: - Ensure all gas appliances are off. Check wiring to gas pressure sensor. Check gas pressure. The system must be reset by pressing "STOP" before it can be restarted.







2.047 - GAS PRESSURE FAULT 2

	POWER ON		GAS VALVE
	SYSTEM CONDITION		
	REMOTE KNOCK OFF		GAS PRESSURE
	FIRE ALARM		FAN

Cause: - The gas pressure has dropped below 12mbar during normal running.

Solution: - See above.

2.048 - EMERGENCY STOP

	POWER ON		GAS VALVE
	SYSTEM CONDITION		
	REMOTE KNOCK OFF		GAS PRESSURE
	FIRE ALARM		FAN

Cause: - The system has been manually stopped by pressing **SYSTEM STOP**

Solution: - Reset the system by pressing **SYSTEM STOP** a second time.

If the above does not solve your problem, contact Trent Products.

** Only on modes with gas pressure proving*

CaterSense the Intelligent answer

2.05 System Checking

As an aid to system commissioning, CaterSense has a diagnostic tool which can be used to quickly check that the stored settings are suitable for correct operation.

To access this tool,

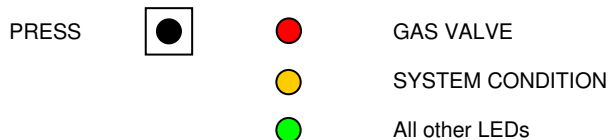

In this mode, the FAN 1 and FAN 2 LEDs will instantly react to the current being drawn by the attached motors. By slowly adjusting the speed control for the motors and observing the LEDs, the parameters can be quickly checked and problems identified.

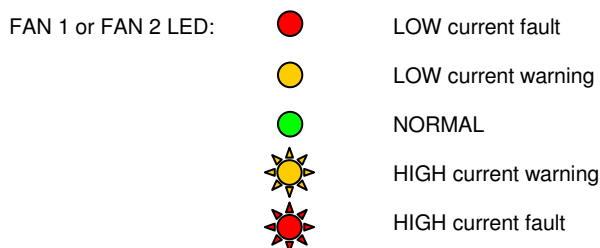

If the current is at a "fault" level for longer than 30s, a system fault would occur during normal operation. It is normal for current draw to fall outside normal levels for a few seconds whilst changing speeds. Allow fan to settle at each speed. IF IN DOUBT, ASK.

Diagnostic mode also allows the manual opening of the gas valve for testing purposes, for a maximum of 5 minutes.

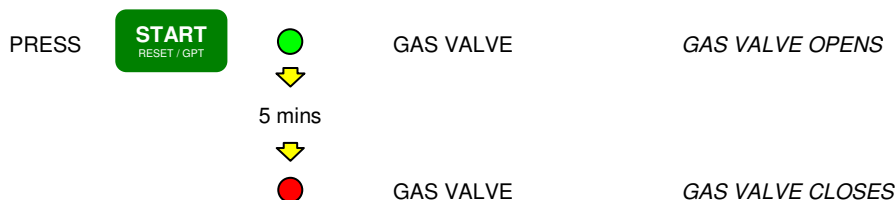

To leave diagnostic mode, press



CaterSense *the Intelligent answer*

FOR FURTHER TECHNICAL ASSISTANCE, PLEASE CONTACT US BY

Phone: 01782 844668

Fax: 01782 844772

E-mail: info@trentproducts.com

Web site: www.trentproducts.com

- Note:
- i) Ensure that the electrical installation has been installed in accordance with the current edition of the IEE regulations.
 - ii) Ensure that the gas installation has been installed in accordance with the current gas regulations (GAS SAFE).
 - iii) If in doubt, ask! (contact us on or by any of the above).
 - iv) Ensure that the client has been shown how to operate the system and that they have been handed the users guide



This symbol on this product or the package indicates that disposal of this product after its lifecycle could harm the environment.

DO NOT dispose of this product (or batteries if used) as unsorted municipal waste. It should be disposed by a specialised company for recycling. This product should be returned to your distributor or to a local recycling service.

Respect the local environment rules.

TRENT PRODUCTS
Trent House
Dewsbury Road
Fenton
Stoke-on-Trent
Tel: 01782 844688 Fax: 01782 844772