



## ***CaterSense -01***

***GAS SUPPLY CONTROL with  
REMOTE CT MONITORING***

***INSTALLATION and COMMISSIONING  
INSTRUCTIONS***

## Product Overview

The CaterSense system is based on a range of products and ancillary equipment designed to meet the ever changing requirements of the catering industry and associated regulations.

The system comes in four basic modes, you have selected

### **CaterSense -01** intelligent controller *with remote CT monitoring*

The controller has a unique "self-set" system which makes for easy system commissioning.

## Contents

- 1.0 General Info
  - 1.01 Opening the unit
  - 1.02 Fixing details
  - 1.03 Cable entry
  - 1.04 Electrical connections
  - 1.05 System mode and set-up (locations)
- 2.0 Set-up and commissioning
  - 2.01 Initial Set-up
  - 2.02 Mode Set-up
  - 2.03 Functional Operation
  - 2.04 Troubleshooting

### 1.01 Opening the unit

The CaterSense unit is made up of the following component parts. Please ensure that all components are present before proceeding.

Product code	Quantity	Description
CS-01-PCB-B1	1	CaterSense-01 enclosure base including main PCB
CS-01-F1	1	CaterSense-01 enclosure facia including PCB
CS-CABLE	1	200mm ribbon cable
CS-SP-01	1	CaterSense enclosure side panel (left)
CS-SP-02	1	CaterSense enclosure side panel (right)
CS-SP-03	2	CaterSense enclosure side panel restraining clip
SCR-03	4	CaterSense facia fixing screw ( <i>No 8 x 3/4"</i> )

1.

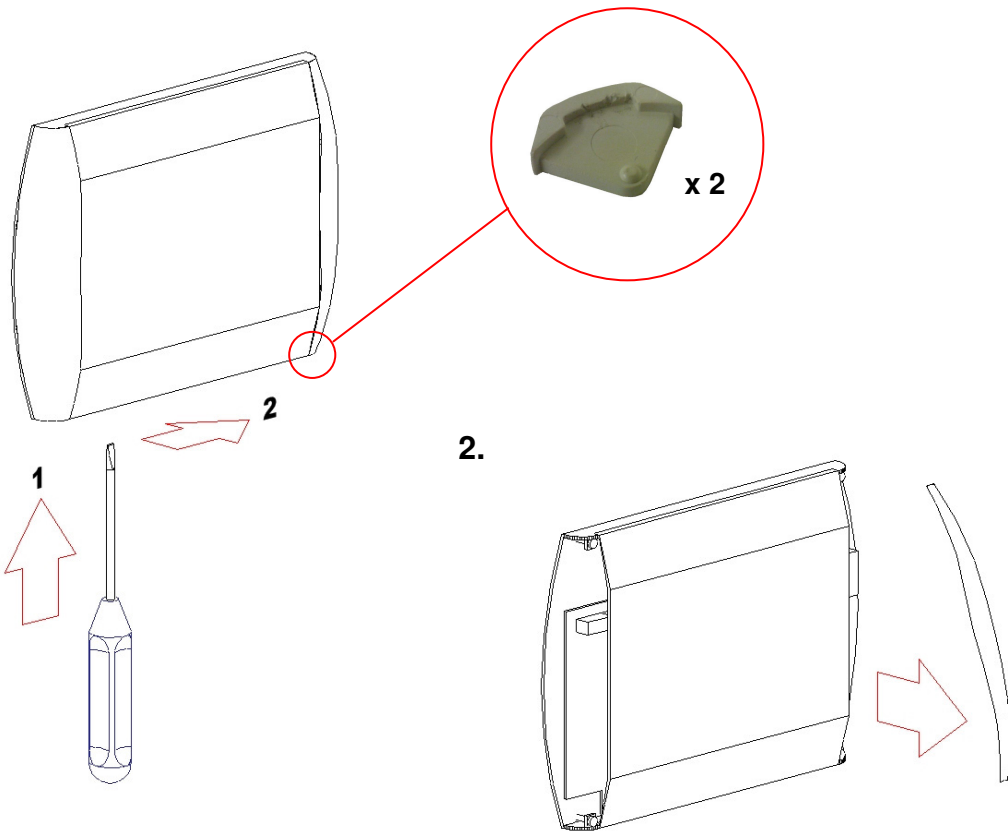

3.

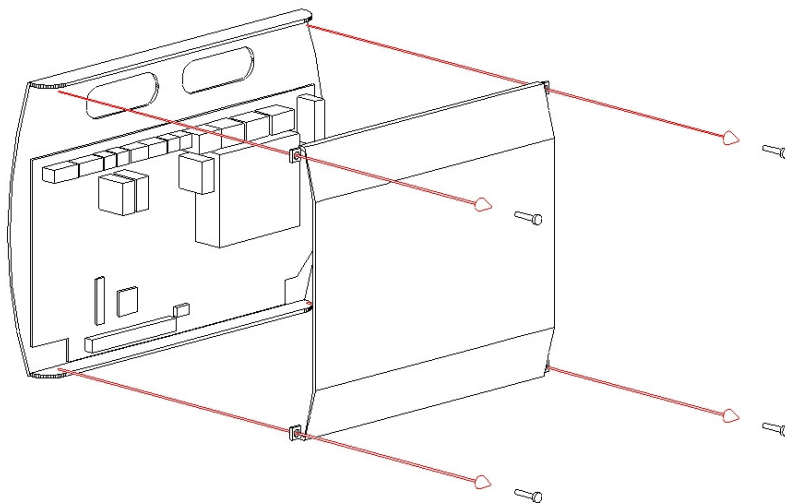

- 1) To open the enclosure, first remove the snap-in clips at the bottom of the two side panels: using a flat bladed screwdriver push the clip from below away from each side panel.
- 2) Press the release pad on each side at the bottom of the enclosure and lift off each side panel in turn by first pulling the bottom towards you. This will reveal the four fascia plate fixing screws.
- 3) Unscrew these four screws and lift the fascia plate from the back box (3), ensuring that the ribbon cable between the two PCBs has been unplugged at the main PCB end.

Place the screws, snap-in clips, side panels and fascia plate in a safe place until the back box has been fixed, wired and is ready for reassembly and set-up.

## 1.02 Fixing details

The CaterSense unit has six (6) mounting holes which can be used (as shown below)

*Note: Ensure that the enclosure is mounted on a clean and level surface away from the direct cooking area or surfaces.*

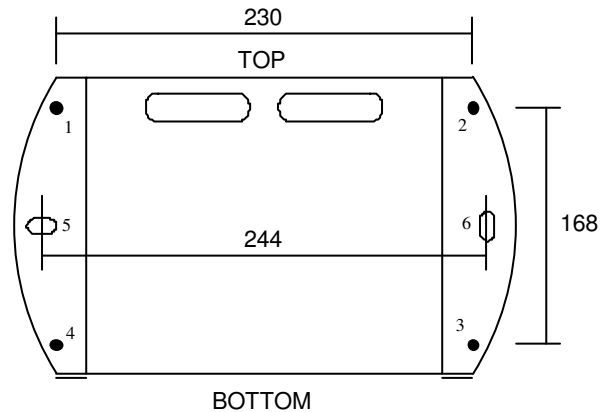

## 1.04 Electrical connections

The CaterSense system has two sets of terminals all mounted along the top edge of the main PCB circuit board.

Terminals 1 to 22 are the smaller terminals (1.5 mm<sup>2</sup> cable) and are used for the sensors, inter-locking devices, remote speed and on/off control. (Screen Cable must be used)

Terminals 23 to 34 are the larger terminals (4 mm<sup>2</sup> cable) and are for the power connections for the fans, gas valve and power supply to the unit.

The terminals are of the rising clamp type protection.

All cabling should be kept to the top of the unit within the designated area. No cables should be placed or laid across the PCBs as they may cause damage.



## 1.05

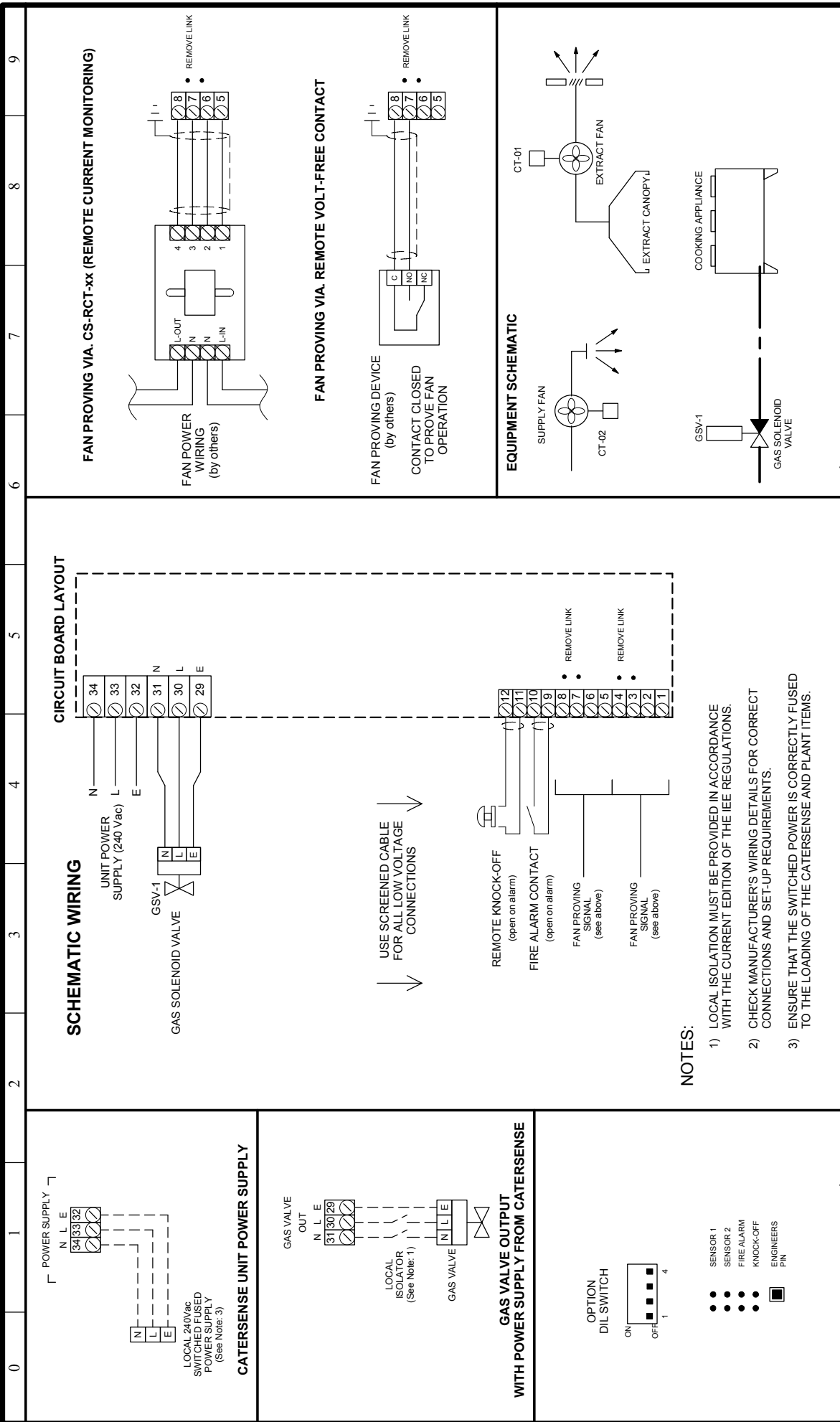

**TRENT PRODUCTS**

Tel: 01782 - 844688 Fax: 01782 - 844772

**IF IN DOUBT, ASK**

**CATERSENSE -1 (01-02)**

**WIRING & CONNECTION DIAGRAM**

**DATE:** 05/01/06

**DRAWING No:** CATERSENSE -1 WD-01-02

**DRAWN BY:** MAE

## 1.06 System mode and set-up

The CaterSense unit is a number of intelligent control solutions in one controller. Each of the solution types has a “Mode Code” which is set via a DIL switch mounted on the main PCB circuit board. The CaterSense also has a unique “Self-set” system commissioning tool which makes for easy system commissioning. These devices are located on the left hand side of the main PCB, under the side cover, as detailed below.

**Follow the instructions in the next section for your model of CaterSense.**

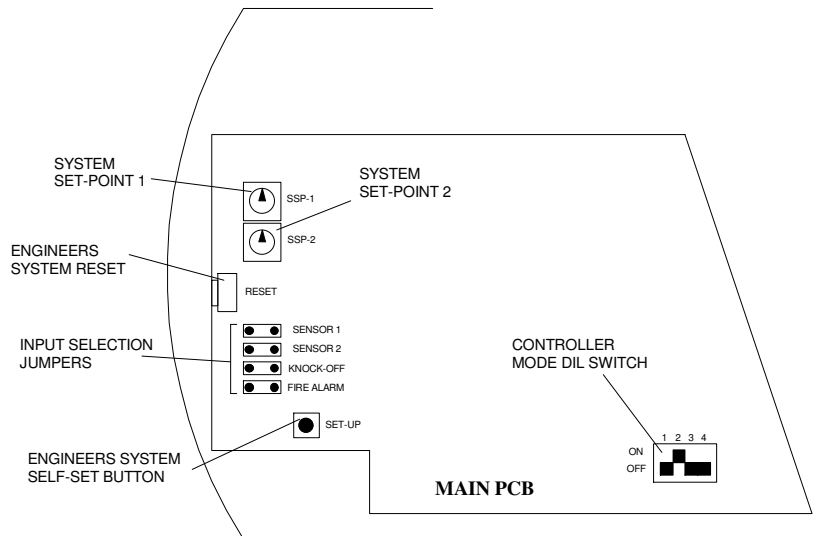

## 2.0 Set-up and Commissioning

The set-up and commissioning of your CaterSense system is in two parts, **Initial** and **Mode**.

### 2.01 Initial Set-up

Once all of the wiring has been completed and tested and the system is ready to be set-up and commissioned, the following sequence **MUST** be followed to ensure the CaterSense and system operate correctly.

- a) **DIL Mode switch**, Ensure the correct system code has been selected on the DIL switch. This code is detailed on the wiring diagram for your installation.
- b) **Input Jumpers**, Ensure that the correct input jumpers have been removed as detailed on the System Mode page for your installation.
- c) **Sensor Links**, If you are using four wire sensors in place of three wire type, remove Link **J3 & J5** as detailed on the System Mode page for your installation.
- d) Ensure that fire alarm and knock-off switches (if fitted) are all in the operational position.

When all of the above stages have been completed, re-assemble the CaterSense unit by reversing the sequence described above in section **1.01**.

**NOTE:** Ensure the ribbon cable is plugged in correctly with the key pin (red stripe) at the **top** on the main PCB, and at the **bottom** on the fascia (see diagram).

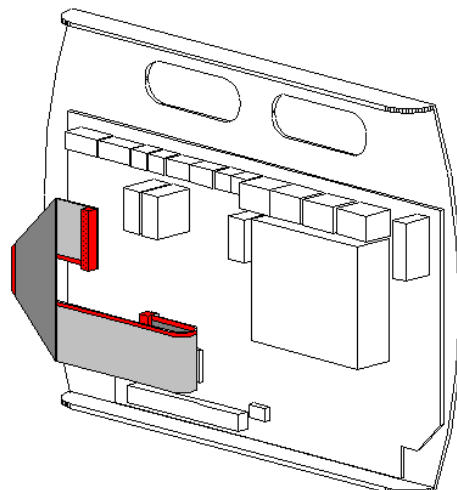

## 2.02 Mode Set-up

Once the above has been carried out, the system is now ready to be powered up.

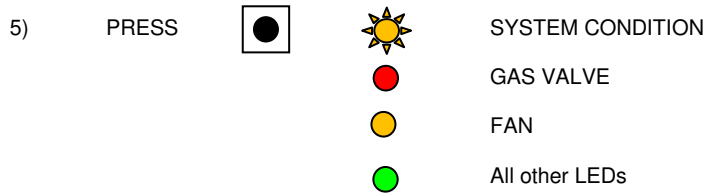

Ensure the fans are running at the speed at which they draw least current. THIS IS NOT NECESSARILY THE LOWEST SPEED. IMPORTANT – allow system to run and settle.

If the fan is monitored via an external source, and the "fan healthy" signal is provided from a volt-free contact, ensure that the contact is closed.

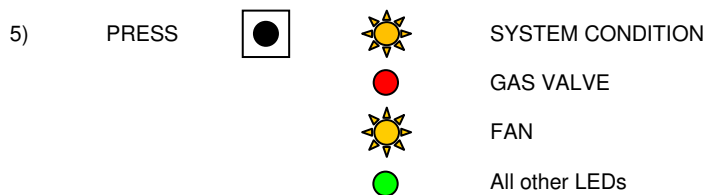

The system will produce a short beep. Change the speed of the fans to the speed at which they draw maximum current. THIS IS NOT NECESSARILY THE HIGHEST SPEED. IMPORTANT – allow system to run and settle.

If the fan is monitored via an external source, and the "fan healthy" signal is provided from a volt-free contact, ensure that the contact is closed.



The set-up is now complete and the system is ready to run.

## 2.03 Functional Operation



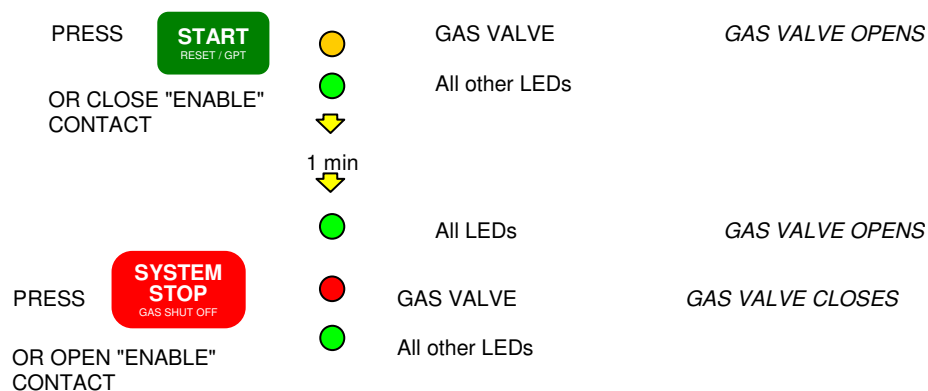



The operation of the CaterSense unit and system in this Mode is as follows:



In the event of a system fault (i.e. gas pressure fault, fan failure, knock-off button depressed, fire alarm detected) the system must be reset by pressing **SYSTEM STOP**.







## 2.04 Troubleshooting

### 2.041 - SYSTEM STOPPED

 POWER ON	 GAS VALVE
 SYSTEM CONDITION	
 REMOTE KNOCK OFF	 FAN1
 FIRE ALARM	 FAN2







Cause: - The system has been stopped  
Solution: - Press "Start" key to begin startup sequence

### 2.042 - FIRE ALARM

 POWER ON	 GAS VALVE
 SYSTEM CONDITION	
 REMOTE KNOCK OFF	 FAN1
 FIRE ALARM	 FAN2







Cause: - The link between terminals 9 and 10 has been broken (fire alarm activated).The fan and gas valve outputs will be deactivated.  
Solution: - Ensure fire alarm is not activated. Check wiring to fire alarm interface panel. The system must be reset by pressing "STOP" before it can be restarted.

### 2.043 - KNOCK OFF BUTTON

 POWER ON	 GAS VALVE
 SYSTEM CONDITION	
 REMOTE KNOCK OFF	 FAN1
 FIRE ALARM	 FAN2







Cause:- The link between terminals 11 and 12 has been broken (knock off pressed). The gas valve output will be deactivated.  
Solution:- Ensure remote knock off button has been released. Check wiring to remote knock-off button. The system must be reset by pressing "STOP" before it can be restarted.

### 2.044 - FAN UNDERCURRENT

 POWER ON	 GAS VALVE
 SYSTEM CONDITION	
 REMOTE KNOCK OFF	 FAN1
 FIRE ALARM	 FAN2

Cause:- The indicated fan is drawing less current than the minimum current established during commissioning.  
Solution:- Ensure fan is working correctly. Check running current with an ammeter. Use the diagnosis mode to establish any problems with set-up. The system must be reset by pressing "STOP" before it can be restarted.







## 2.045 - FAN OVERCURRENT

	POWER ON		GAS VALVE
	SYSTEM CONDITION		
	REMOTE KNOCK OFF		FAN1
	FIRE ALARM		FAN2

Cause:- The indicated fan is drawing more current than the maximum current established during commissioning.

Solution:- Ensure fan is working correctly. Check running current with an ammeter. Check filters are clean. Use the diagnosis mode to establish any problems with set-up. The system must be reset by pressing "STOP" before it can be restarted.

## 2.048 - EMERGENCY STOP

	POWER ON		GAS VALVE
	SYSTEM CONDITION		
	REMOTE KNOCK OFF		FAN1
	FIRE ALARM		FAN2

Cause:- The system has been manually stopped by pressing **SYSTEM STOP**

Solution:- Reset the system by pressing **SYSTEM STOP** a second time.

**If the above does not solve your problem, contact Trent Products.**

*\* Only on modes with gas pressure proving*

**Notes:**

**Notes:**

FOR FURTHER TECHNICAL ASSISTANCE, PLEASE CONTACT US BY

Phone: 01782 844668

Fax: 01782 844772

E-mail: [info@trentproducts.com](mailto:info@trentproducts.com)

Web site: [www.trentproducts.com](http://www.trentproducts.com)

- Note:
- i) Ensure that the electrical installation has been installed in accordance with the current edition of the IEE regulations.
  - ii) Ensure that the gas installation has been installed in accordance with the current gas regulations (GAS SAFE).
  - iii) If in doubt, ask! (contact us on or by any of the above).
  - iv) Ensure that the client has been shown how to operate the system and that they have been handed the users guide



This symbol on this product or the package indicates that disposal of this product after its lifecycle could harm the environment.

DO NOT dispose of this product (or batteries if used) as unsorted municipal waste. It should be disposed by a specialised company for recycling. This product should be returned to your distributor or to a local recycling service.

Respect the local environment rules.

**TRENT PRODUCTS**  
Trent House  
Dewsbury Road  
Fenton  
Stoke-on-Trent  
Tel: 01782 844688 Fax: 01782 844772